



DIMORIA COLLEGE, KHETRI



Accredited by NAAC with B++ Grade

PROSPECTUS 2024-25

M.A./M.Sc. in
Assamese, Economics, Eco-
restoration, Geology &
Environment Management,

FYUGP under
NEP 2020
Arts and Science

Higher
Secondary in
Arts & Science



Departments offering Major & Minor Courses in FYUGP:

Arts:

Anthropology, Assamese,
Economics, Education,
English, Geography, Hindi,
History, Mathematics,
Political Science.

Only Minor Courses in
Folklore, Linguistics and
Statistics.

Science:

Anthropology, Botany,
Chemistry, Computer
Science, Economics,
Geology, Geography,
Mathematics, Physics,
Zoology.

Only Minor Courses in
Biotechnology and Statistics.



Mr. Manabjyoti Barkakaty
Principal i/c

Dimoria College, Khetri,
Kamrup(M), Guwahati,
Assam 782403



বিজয়তু ডিমৰীয়া মহাবিদ্যালয় ড: প্রমোদ চন্দ্র ভট্টাচার্য

বিৰাজিছে স্কেত্ৰী নগৰত ডিমৰীয়া মহাবিদ্যালয়।
জনে জনে বিদ্যাৰ্থীয়ে লয় আহি জ্ঞানৰ আশ্ৰয়।।
য়ই কয় লুইতৰ দক্ষিণ পাৰত শোভে অনুপম।
তুষিব অসম মাতৃ পৰিশ্ৰম কৰি নিতে অবিৰাম।।
ডিমৰীয়া বাঢ়ে আগ স্মৃতিপট নৱৰূপে কৰি নিৰমান।
মনবোৰে গঢ়ি তোলে দেহত্ৰী জোখাৰে কৰ্মত হ'ব শক্তিমান।।
বীতি-নীতি মানৱৰ আদৰ্শ ভাৰতৰ সত্য-শিৱ - সুন্দৰৰ পথ।
য়ই কয় অসমীয়া মন হ'লে উঠনীয়া আৰোহীৰ জীৱনৰ পথ।।
মহাপুৰুষৰ বাণী ধন্য ভাৰতভূমি প্ৰাগজ্যোতিষৰ নৰ আমি।
হাবিৰ নাই ভয় সংগ্ৰামত হ'ব জয় আগবাঢ়ে মাতৃক প্ৰণামি।।
বিদ্যাৰ মন্দিৰখনি উজলি উঠক-আয়োজিত ভাষা -সন্মিলন।
দ্যা- ৰূপে আদ্যশক্তি সবৰো সন্তৰত কৰ্ম জ্ঞান কৰে বৰিষণ।।
লগ্ন দেখি অনুষ্ঠিত ভাষাবিজ্ঞানৰ এয়া জ্ঞান তত্ত্বোদয়।
য়ই কয় বিজয়তু নবোদিত ডিমৰীয়া মহাবিদ্যালয় ।।

(অসম ভাষাবিজ্ঞান সমিতিৰ একাদশ বাৰ্ষিক স্কেত্ৰী সন্মিলন
উপলক্ষে ৰচিত নামাঙ্কৰী)

Oath for the Youth

- I will have a goal and work hard to achieve that goal. I realize that small aim is a crime.
- I will work with integrity and succeed with integrity
- I will be a good member of my family, a good member of the society, a good member of the nation and a good member of the world.
- I will always try to save or better someone's life, without any discrimination of caste, creed, language, religion, or state. Whenever, I am, a thought will always come to my mind. That is "What can I Give".
- I will always protect and enhance the dignity of every human life without any bias.
- I will always remember the importance of time. My motto will be "Let not my winged days be spent in vain".
- I will always work for clean planet Earth and clean energy.
- As a youth of my nation, I will work and work with courage to achieve success in all my tasks and enjoy the success of others.
- I am as young as my faith and as old as my doubt. Hence, I will light up then the lamp of faith in my heart.
- My national flag flies in my heart and will bring glory to my nation.

MESSAGE

From the Honorable President, Governing Body



Dear Esteemed Prospective Students,

As the President of the Governing Body of Dimoria College, I am honored to extend my warmest greetings to each of you as you embark on this pivotal journey towards higher education. With great pride and anticipation, I pen these words of gratitude, welcoming you to explore the endless possibilities our esteemed institution offers.

I want to express my heartfelt appreciation to all who have chosen to consider Dimoria College for their academic pursuits. Your interest in our institution is a testament to our reputation as a beacon of excellence in education. We are thrilled to welcome a diverse and talented cohort of individuals, each bringing their unique perspectives, passions, and dreams to our vibrant campus community.

At Dimoria College, we have always been dedicated to nurturing a culture of innovation, academic excellence, and personal growth. We believe in providing our students a supportive environment that fosters curiosity, critical thinking, and a lifelong love for learning. Our esteemed faculty members will carefully evaluate each application throughout the admission process, recognizing and celebrating every applicant's unique strengths and potential.

Choosing the right educational path is a significant decision that profoundly shapes your future. Our admission process is designed to be transparent, equitable, and thorough. We value academic achievements and our applicants' character, passion, and extracurricular pursuits. Our goal is to cultivate a diverse community of scholars where students can learn from one another's experiences and emerge as well-rounded individuals poised to make meaningful contributions to society.

To the parents and guardians entrusting us with their children's education, I want to assure you that we recognize the weight of your decision. We are committed to providing a nurturing and inclusive environment where students can thrive academically, emotionally, and socially. Your children's well-being and success are our top priorities, and we are dedicated to supporting them in every step of the way.

To our prospective students, I encourage you to embrace this opportunity with open arms, dream boldly, and seize the possibilities. While the road may be challenging, it is also filled with boundless opportunities for growth, discovery, and personal transformation. We eagerly await the chance to welcome you into our vibrant community and witness the incredible contributions you will undoubtedly make.

In closing, I extend my warmest welcome to all of you. Thank you for considering Dimoria College as your educational home. Together, let us embark on a journey of learning, exploration, and self-discovery that will shape the course of your future endeavors.

Thank you,
Dr. Kamal Barman

OFFICE OF THE PRINCIPAL**DIMORIA COLLEGE**

P.O.-KHETRI-782403, KAMRUP (M), ASSAM

e-mail : dimoriacollege.khetri@gmail.com

**FROM THE PRINCIPAL'S DESK**

Namaskar,

Dimoria College, situated in the urban fringed of Guwahati city with a travel distance of 35 km from the state capital of Assam has a glorifying history of nearly 45 years. The college was established in the year 1979 in a small classroom at Khetri High School with fifty-seven students and three teachers. Late Pandit Binanda Chandra Barman was the founder Principal (1979-80) followed by Late Hari Prasad Medhi (1980 - March, 1981). Sri Ram Charan Bharali assumed the stewardship of the College on 14th April, 1981 and retired on 31/12/2010. Arts Stream of the college was brought under deficit grants-in-aid system on 1, February, 1986. The Science Stream was brought under deficit grants-in-aid system in 1996. Always striving for the goals of greater excellence, the college engulfs a rich mosaic of 22 departments offering graduate courses and offers Post-Graduate degree in 4 subjects including emerging Science Course in Eco-Restoration and Environmental Management. The college has an adorning antiquity of being the third college of Assam to have been accredited with 'A' in the assessment conducted by NAAC in the year 2010, being the only rural Post Graduate Institution in Assam. After a gap of 13 years due to several administrative reasons, the college has bounced back in restoring its splendid past of academic excellence, Dimoria College, Khetri received 'B++' in the latest NAAC accreditation process conducted in the years 2023. The present-day college has a sprawling campus of more than twenty-four bighas of land including built up areas and a spacious playground that craters academic requirement aspirations of nearly 2500 students studying in various educational levels offer by the college. Facilities include a well-stocked modern library with photocopying and Internet facility, Departmental Libraries, well equipped laboratories, a Computer Science cum IT Department, hostels for girls together with a multipurpose Auditorium complex. The college has completed many minor and major research projects and continuing several others sponsored by the UGC. Presently more than one hundred forty teaching & non-teaching staff are working in the college for promotion of teaching, learning, evaluation, innovation, research and extension services for the greater goal of social upliftment. Here at Dimoria College, Khetri we are committed to fostering a nurturing environment that promotes academic excellence, personal growth, and holistic development. Our curriculum is designed to equip students with the skills, knowledge, and values necessary to thrive in an ever-changing world. As you explore this prospectus, you will discover our wide range of academic programs, extracurricular activities, and support services tailored to meet the diverse needs of our students. We take pride in our dedicated faculty and staff who are passionate about education and are committed to providing a stimulating and safe learning environment. We invite you to embark on this journey with us and become part of a community that values curiosity, creativity, and character. Together, let us inspire and empower the next generation of leaders and lifelong learners.

Regards
Manabjyoti Barkakaty
Principal I/C
Dimoria College Khetri

Contents

- Dimoria College, Brief history-cum-profile/1
 - Vision & Mission, Core values, Goals & Objectives /3
 - Location/4
 - Facilities available/5
 - Activities/7
 - Incentives and Awards/8
 - Agenda for the Session 2024-25/8
 - Achievements/9
 - Curriculum and combination of subjects /10
 - Fees structure for PG Courses/16
 - Rules and Regulations /17
 - Principal and teaching staff /18
 - Non - teaching staff /20
 - The FYUGP course structure of Gauhati University/21
 - Campus Map/27
-

DIMORIA COLLEGE

A Brief History-Cum-Profile

Dimoria College is the brainchild of a group of highly motivated social entrepreneurs who in the seventies dreamt of bringing the gospel of higher education to this relatively backward tribal belt area of Dimoria. Led by the indomitable zeal of patrons of learning like late Padmakanta Deka (Founder President), Late Santa Ram Deka (Founder Secretary), late Prasanna Deka, Late Gopinath Sarma, Late Krishna Kanta Bhuyan, the people of Dimoria started a public campaign for the establishment of a College. Their efforts were augmented by donation and cooperation from all sections of local society ranging from rich businessmen like Omkarlal Agarwala to humble thelawalas and firewood sellers.

The college was inaugurated on 29th August, 1979 in a small classroom at Khetri High School with fifty seven students and three teachers. Late Pandit Binanda Chandra Barman was the founder Principal (1979-80) followed by Sri Hari Prasad Medhi (1980 - March, 1981). Sri Ram Charan Bharali assumed the stewardship of the College on 14th April, 1981 and retired on 31/12/2010. Dr. Biman Kumar Bhatta has joined this college as principal on 27/06/2020.

Arts Stream of the college was brought under deficit grants-in-aid system on 1st February, 1986. This development encouraged the college to open Science Stream in H.S. level in the year 1987. B.Sc. Course was started in 1992 and the Stream got a fillip with the inauguration of the Ambedkar Science Block by the then Hon'ble Vice-President of India, Sri K. R. Narayanan. The Science Stream was brought under deficit grants in-aid system in 1996.

Always striving for the achievement of set goals of greater excellence, the college opened Post-Graduate Classes in Assamese, Political Science and Economics in 1992. Famous Scholars like Prof. V.V. Rao & Sahityacharya Prof. Golak Ch. Goswami used to take P.G classes in the early years and help and encourage the college with their invaluable advice and wisdom. A new feather was added to the P.G wing in 2004 with the introduction of a totally unique and emerging Science Course in Eco-Restoration. In 2008, Dimoria College earned the rare distinction of signing a memorandum of understanding with Brandenburg Technical University, Cottbus, Germany on mutual exchange of students and faculty and evaluation of courses of study along with mutual recognition of Eco-restoration students' performance in Dimoria College. It was followed by the introduction of a P.G Course in Environment Management in the year 2008. Apart from these, several U.G.C. sponsored Vocational Courses along with Distance Education Programme under the IGNOU have also been introduced. In recognition of the values and social orientation of the College, U.G.C. has provided it with a Centre for Ambedkar Studies with the objective of spreading the teachings and philosophy of Dr. B. R. Ambedkar.

In addition to the hard work and perseverance of the college community, we are blessed to have among our patrons, a great intellectual figure like former Prime Minister Dr. Manmohan Singh who has visited the college on more than one occasion and extended his helping hand in the completion of various projects of the college. Being the only rural Post Graduate Institution in Assam, Dimoria College was awarded 'A' Grade by NAAC in recognition of its role as a harbinger of social change through the instrument of higher education. The year 2010 saw our college being placed in the coveted position of a College with Potential for Excellence by the UGC where by it has earned the highly cherished membership of a select club of 149 colleges out of more than 6000 colleges throughout India under UGC's recognition. The august arrival of Former President of India Dr. A.P.J. Abdul Kalam to our college on 6th February, 2010 to motivate our students in the path of nation building was the jewel on the crown of the above achievements. Thus, from a very humble beginning in 1979 the college has matured itself into a full-fledged centre for learning and excellence.

The present-day college has a sprawling campus of more than twenty-four bighas of land including built up areas and a spacious playground. Facilities include a well-stocked modern library with photocopying and Internet facility, Departmental Libraries, well equipped laboratories, five P.G. Departments, a Computer Science cum IT Department, a Language Laboratory, a Canteen for students, teachers & non-teaching staff, two five separate hostels for girls together with a multipurpose Auditorium complex. The college has completed many minor and major research projects and continuing several others sponsored by the UGC. Presently more than one hundred forty teaching & non-teaching staff is working in the college for promotion of teaching, learning, evaluation, innovation, research and extension services for the greater goal of social upliftment.

Long live Dimoria College.

N.C.C. (National Cadet Corps)

Dimoria College has NCC girls' programme under 60 Assam Girls' Battalion which is one of the best in the state. It looks after the physical, moral and psychological aspects of the girl students. It has an intake capacity of 54 cadets.

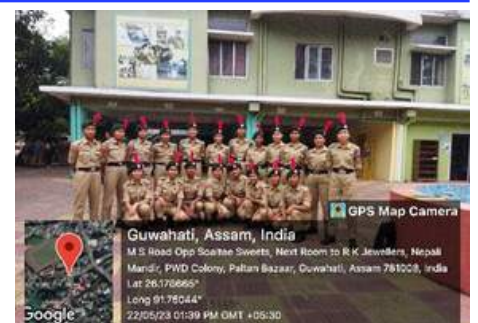

60 Assam Girls' Battalion NCC of Dimoria College



NAAC Peer Team visit to the College in June, 2023

VISION, MISSION AND CORE VALUES

VISION

The vision of Dimoria College is to mould the character of the future generations as competent citizens of the nation, who can be self-reliant and source of inspiration for others through the instrument of higher education.

MISSION

Dimoria College is passionate about providing higher education for upcoming generations in this educationally and socially backward region, predominantly inhabited by various tribal and ethnic groups.

The College is committed to growing scientific thinking and strives for awareness against superstitions and unscientific beliefs and for global environmental issues.

The College aims to prepare skilled individuals to generate entrepreneurial avenues.

Core Values

- Economic and Social Responsibility
- Environmental Sustainability
- Empowering Scientific Temperament.

GOALS & OBJECTIVES

- The College was established with the following distinct goals and objectives.
- Comprehensive development of the socially disadvantaged and economically backward people.
- Dissemination of knowledge of different branches of modern science and humanities.
- Production of enlightened human resources in the region in order to bring about all round development.
- To bring about a change in the attitude of the new generation learners towards a better environment in the region.
- To instill a sense of social responsibility in the minds of the students and generate an awareness about their rights and duties as conscious citizens of India.

Financial Literacy Club

PG Department of Economics has launched a Financial Literacy Club with the intension to literate financially its students, teachers and the community at large. The mission of the club is to empower the members with the knowledge and skills necessary to make informed financial decisions and to achieved their financial goals



Talk on "From Savings to Prosperity: How Mutual Funds can Grow Your Money" organized by the Financial Literacy Club.

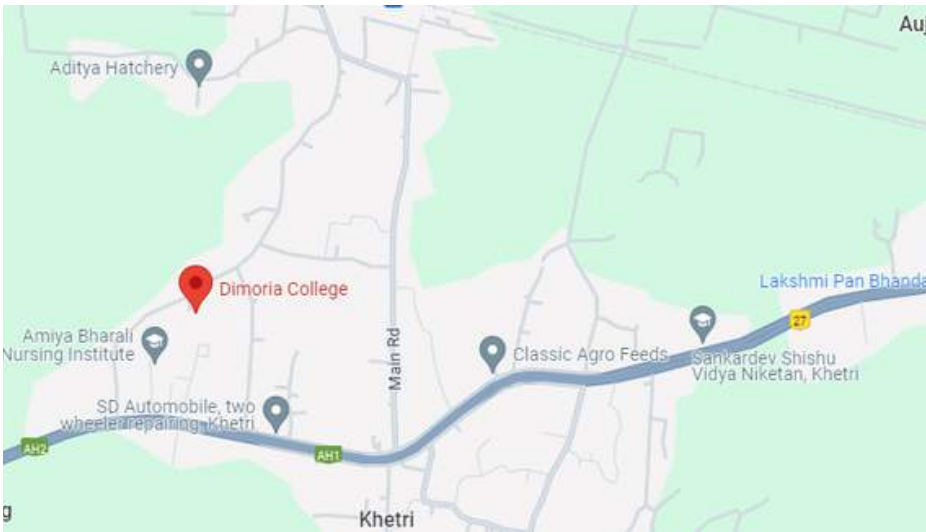

LOCATION OF THE COLLEGE

Dimoria College is located at Khetri, about 30 kms. to the East of Guwahati City on N.H. 37 with excellent communication facility. It is situated in the Dimoria Tribal Belt, a part of Dimoria LAC under Kamrup (Metro) District. The area is located close to the north eastern fringes of the Meghalaya Hills and western part of Morigaon District.

Dimoria, the erstwhile medieval principality, is the symbol of rich cultural and ethnic diversity, being predominantly inhabited by different colourful tribes like the Karbis, Tiwas, Bodos, Garos alongside Bengalis, Tea Tribes and non-tribal Assamese population. Far from the madding crowd, an idyllic surrounding of blue hills and lush green valley, coupled with a diversified ethnic, cultural and geographical setting, makes the location of the college a perfect heaven for intellectual pursuit of the highest order.

Latitude and Longitude: 26° 07' N 92° 04' 33" E

K. K. HANDIQU STATE OPEN UNIVERSITY Dimoria College Study Centre

KKHSOU Study Centre, Dimoria College, Khetri was established in 2020 in the month of September. The Study centre offers both Under Graduate and Post Graduate courses. The Principal of the college is the In-Charge of the Centre and the Co-ordinator of the Centre is Dr. Bipul Kumar Das (Phone Number: 7002592163). Following are the courses offered by the study centre:

Undergraduate Courses:

Honours: English, Assamese, Political Science, Economics, Education.

Regular: Political Science, Education, Economics, English, Assamese.

Post Graduate Courses:

Education, Political Science, Assamese

Electoral Literacy Club

Electoral Literacy Club (ELC) of Dimoria College is a platform to engage college students and people in villages through interesting activities and hands-on experience to sensitise with their electoral rights. The main objective of ELC is to promote awareness of 'Right to vote' among students, faculty members and community at large.

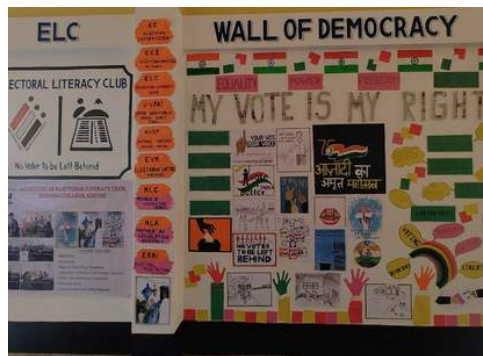

Wall of Democracy by Electoral Literacy Club of Dimoria College, Khetri



First Voters and SVEE Participation organized by Central Bureau of Communication, Ministry of Information and Broadcasting, GoI



Central Library, Dimoria College, Khetri

FACILITIES AVAILABLE

Class Room: Sufficient numbers of class rooms with varying sizes are available for smooth conduct of different classes in the College.

Laboratories: State of the Art Laboratories with sufficient space and all the necessary equipments are made available to various departments. The Department of Science & Technology & UGC, Govt. of India have provided them with various newly equipped

software like GPS & GIS and a new Air conditioned Computer Lab. which is being jointly utilized by the Departments of Environment Management & Computer Science. The laboratory of Geology Dept. is recognized by Gauhati University for Ph.D. research.

Museum: The College has four museums in the Deptt. of Assamese, Anthropology, Folklore and Geology. They boast of a rich collection of artifacts and different cultural items of high value. Their objective is to highlight the rich ethno-cultural heritage of Assam in particular and North-East in general.

Central Library:

The Dimoria College Library is constructed with a State of the Art design and situated at a very calm location. It remains open from 10.00 am to 4.00 pm. Students may borrow books from the library against library cards issued to them. The Central Library has a collection of approximately 24,000 books. Moreover, there are more than 12,000 books available in different departmental libraries. A good number of National & International Magazines, Periodicals, Journals and Newspapers are subscribed by the Library which has also got a rare reference book collection. The Library is automated by the SOUL software developed by INFLIBNET center. The library has a digital repository of their own from where students can access question papers and college publications from anywhere. The library also has Wi-Fi facility and internet section; both can be used for academic purpose only.

Departmental Libraries: The college has 22 departmental libraries consisting of 9151 books in those departments.

Art and Craft Club

Dimoria College's Art and Craft Club helps students explore their talents in painting as well as handcrafting with sustainable ingredients, while also encouraging entrepreneurship. Every year, we host an Art and Craft meet, where students exhibit their creations, promoting creativity and possible sale skills.



Art & Craft Club of Dimoria College, Khetri



Folk dances of Assam, as depicted on the College wall



Girls Hostel 2, Dimoria College, Khetri

FACILITIES AVAILABLE

Internet: The College has a well-equipped Internet facility in the library building with all the facilities of downloading and printing. Moreover all the Departments are linked to the internet through Wifi system.

Audio Visual Aid: Dimoria College possesses overhead LCD Projectors, Laptops, DVD Players etc. which are used for Teaching, Learning, Seminars and Conferences.

Hostel Facilities: Hostel facilities for girls are available. There are two hostels for girls. Hostel seats are allotted strictly on merit basis. Students can apply for hostel seats after taking admission to the college.

Canteen: Canteen for students, teachers & nonteaching staff is available in the college and remains open during working hours.

Sports Infrastructure: The College has got a large playground, Basket Ball Court and facilities and equipment for different sports like Cricket, Football, Volleyball, Hockey, Badminton, Table Tennis and so on.

Scholarship: Students belonging to SC/ ST/ OBC/ MOBC are awarded scholarship as per Govt. of Assam rules. This includes merit scholarship also.

Students' Aid Fund: The College provides financial assistance to a limited number of students every year who are economically poor. Physically Challenged students are provided with free accessories by the college.

ICGC: The Information and Career Guidance Cell creates awareness of career prospects, self-employment and entrepreneurship as career options among the students, Grievance Redressal Cell: This Cell is formed to receive, scrutinise and redress all genuine grievances and complaints of the members of teaching, non-teaching and student community of the college.

Anti-Sexual Harassment Cell (Internal Complaints Committee):

The college has established an Anti-Sexual Harassment Cell as per the guidelines of the Honourable Supreme Court, UGC, Sexual Harassment of Women at workplace (Prevention, Prohibition and Redressal) Act 2013. This step has been taken with an aim to provide a disciplined, healthy and congenial atmosphere to all the students and employees.

Help Line Number: 9854748506.

YUVA TOURISM CLUB

Dimoria College, Khetri, Assam has started the Yuba Tourism Club on 07/08/2023 with 25 nos of students across the departments with aims to foster an environment of exploration, cultural understanding and sustainable tourism. This initiative aligns with our commitment to provide holistic education and extracurricular activities for personal and intellectual growth. This club takes a positive stance regarding the 'Awesome Assam' project of the govt and focuses on the Dimorian culture.



Yuva Tourism Club Members and Coordinator



Cultural Rally during College Week, 2024

ACTIVITIES

Personality cum Skill Development Sessions: The College gives maximum emphasis on the development of moral character, discipline, punctuality, accountability, sense of dedication to the society, awareness against illiteracy, superstitions and other social evils among the students. For that purpose, personality cum skill development sessions are being frequently held in the college campus. Students are being trained in the skills of acting, debating, recitation, singing, dancing, oratory, quiz, group discussion, essay writing, spoken English, social service and so on.

Students' Union: The Dimoria College Students' Union (D.C.S.U.) is the General Body of the students of the College. Its membership is compulsory for every Dimorian. Office bearers are elected annually as per the constitution of the Student's Union. A student who does not have 75% of attendance in the class on the date of submission of nomination papers for the post of office bearer of D.C.S.U., will not be eligible for contesting the election.

College Festivals and Functions: Dimoria College organizes different cultural programmes apart from its regular annual programmes like Freshers' Social, College Week etc

N.C.C. (National Cadet Corps): Dimoria College has NCC girls' programme under 60 Assam Girls' Battalion which is one of the best in the state. It looks after the physical, moral and psychological aspects of the girl students. It has an intake capacity of 54 cadets.

N.S.S. (National Service Scheme): Dimoria College NSS unit is active since 1985 and has organised various programmes since its inception. The National Service Scheme (NSS) is a student youth service programme. This scheme is sponsored by the Ministry of Youth Affairs and Sports, Govt. of India.

It aims at arousing social consciousness of the youth with an overall objective of personality development of the students through community service.

The NSS volunteers will be trained in life skills, Personality Development, Leadership skills etc. The volunteers get opportunities to participate in various state and national level camps.

RRC: Red Ribbon Club is sponsored and supported by the Assam State AIDS Control Society (ASACS). The students are trained in AIDS awareness and motivated for voluntary Blood Donation.

SRIJANEE: the Society for Performing Arts & Culture



Dimoria College frequently organises cultural programmes and provides training on poetry, drama, literature, dance etc. In January 2022, SRIJANEE: the Society for Performing Arts & Culture has been opened in the college.



SRIJANEE Group's performance during NAAC Peer team visit

Sports Activities: Dimoria College in cooperation with Dimoria Krira Santha and other sports associations of the state gives training in various sports like cricket, football, volleyball, basketball, badminton, kabaddi, khokho etc. in the college playground. Similarly, sports competitions are being held in the college ground at local as well as state level.



A book launch program by the Director of Higher Education, Govt of Assam

INCENTIVES, AWARDS AND AGENDA

- For those students who are meritorious but economically weak, the College has a special provision for fees relaxation during the time of study in the college.
- Student who secures 75% or more marks in aggregate in his/her Final Examination is awarded a cash prize of Rs. 1000/- (Rupees one thousand only).
- Student of TDC/FYUGP who secures the highest aggregate marks with distinction in the TDC/FYUGP sixth semester final Examination is declared the Best Graduate of the year with special prizes, both in cash and kind.
- Best Reader Prize is awarded to a student for the maximum and best use of the library facilities.
- Besides, many departments have their respective awards. For example, the PG department of Economics offers Awards to Best Graduate in Economics & Highest Scorer in Economics in HS final in cash and in kind.

AGENDA FOR THE SESSION 2024-2025

For this session college has the following plans:

1. To enhance number of class rooms with state of the art technology by extending the new academic building.

2. To increase the stock of books in the college library.
3. To increase the facilities in the various laboratories and equip those with new computer software and Hardware.
4. To establish Research & Development Cell to promote research among faculties of the college, especially in the P.G. department of Assamese, Economics, Eco-Restoration and Environment Management, which is already under process.
5. The College has applied for conferment of autonomous session from the next academic sessions.

6. The college has also applied for DST-FIST program for the departments of Eco-restoration and Environmental Management.

The college has already upgraded the different science laboratories of under graduate and post graduate departments, funded by DST & UGC, New Delhi under DST-FIST, NER special packages. The college has upgraded sports facilities, library facilities including purchase of new books & journals under RUSA infrastructure dev. fund, Ministry of HRD, Govt. of India.

Eco-Club

The Eco-Club of Dimoria College, Khetri is sponsored by the State Nodal Agency: Assam Science Technology & Environment Council, Bigyan Bhawan, G.S. Road, Guwahati – 781005 under the National Green Corps Programme, Ministry of Environment Forest & Climate Change, Govt. of India.

Under this programme with an annual grant of Rs. 5000/- from the funding agency along with the Eco-club Co-ordinator a good number of teachers and students participate in the various programmes of sapling plantation, conduction of cleanliness drive in the College, organization of seminars and meetings, etc.



Campus cleaning by the Eco-Club members of Dimoria College

ACHIEVEMENTS

Appointed as Assistant Professor



Malabika Baruah, appointed in the department of Education, Baksa Govt. Model College



Pranjit Kalita, appointed in the department of Education, MC College, Barpeta



Parna Medhi, appointed in the department of Assamese, MNC College, Nalbari



Devishree Pator, Appointed in the department of Education, Bagbar Govt. MC Barpeta



Munni Borah, Appointed in the department of Botany, Nabajyoti College, Barpeta

Appointed by APSC



Bhaskar Jyoti Dihingia (Geology), Assistant Accounts Officer



Ribu Saikia (Geology), BDO



Bhanita Rahang (Botany), Assistant Accounts Officer



Gitanjali Pathak (Geography), Assam Urban Administrative Service

Qualified UGC NET



Samir Das (Economics) NET, 2023



Mukul Das (Economics), NET, 2023



Antaripa Boro, Assamese, NET, 2023



Urbashi Tumung, Assamese, NET, 2023



Siranjib Deka, Geography, NET, 2023



Fanjamuthi Narzary, Electronic Science, NET, 2023



Lakhyajyoti Hazarika, Assamese, NET with JRF, 2023



Usha Thakuria (Hindi), NET, 2023



Tulika Mushahari, Assamese, NET, 2023



Priyanka Bhagwati, Assamese, NET with JRF, 2023

CURRICULUM FOR TWO YEARS H.S. COURSE IN ARTS & SCIENCE

Eligibility: HSLC Pass / CBSE Class X Board Exam Pass)

Combination of Subjects:

I. Higher Secondary (Arts):

1. English
2. MIL (Assamese/Hindi/ Alternative English)
3. Environmental Education (for H.S. 1st year)
4. Elective Subjects: Choose any four subjects, one from each group.
 - a. Group-A : Geography/ Anthropology/Statistics/ Computer Science and Applications
 - b. Group-B : Economics / History
 - c. Group -C : Political Science / Advance Assamese
 - d. Group- D : Education/ Mathematics/ Swadesh Adhyayan

N.B. Students opting statistics and Computer Science must have mathematics as one of the subject.

II. Higher Secondary (Science)

1. English
2. MIL (Assamese/Hindi/Alterative English)
3. Environmental Education. (for H.S. 1st year)
4. Physics
5. Chemistry
6. Elective Subjects: Choose any two subjects from two different group
 - a. Group A: Mathematics
 - b. Group B: Biology
 - c. Group C: Geology, Statistics, Computer Science and Applications, Anthropology, Geography.

N.B.: Students opting for statistics or Computer Science & Applications must have Mathematics as one of the subject.

Fee: As per Government Instructions.

INSTITUTIONAL BIOTECH HUB

The Institutional Level Biotech Hub (sponsored by DBT, Govt. of India) of Dimoria College, was established in the month of January, 2014, under the Department of Biotechnology, Dimoria College. The objective of the Biotech Hub is to popularise biotechnology among students and teachers from schools and colleges, conducting hands on trainings, outreach programs and popular lectures on regular basis. The hub is also planning to conduct studies on molecular marker based diversity analysis of various indigenous Capsicum varieties and some other important plants of North-East India. The priority of research and development area of this Biotech Hub will be Functional genomics and Medical microbiology. The Hub is well-equipped to conduct research activities. Under the hub, many training programmes were conducted.

FOUR-YEAR UNDERGRADUATE PROGRAM (FYUGP) UNDER GAUHATI UNIVERSITY

Admission to FYUGP shall be done as below:

I. Eligibility:

- A student who has passed 12 standard or equivalent examinations in any stream from a recognized institution.
- Admission to the FYUGP will be based on the preference of Major, if any. In case a student does not want to opt for any major, s/he will be admitted on the basis of the preferences of the subject combinations.
- Admission to a Programme or Major will be subject to availability of the subject and capacity of a college/department.
- No student shall be eligible for admission to a Program in any discipline under the FYUP unless s/he fulfills the pre-requisites of courses as fixed by the university.

II. List of Prerequisites & Requirements: *See Page No. 25-28.*

III. Combinations of Subjects for

FYUGP in Arts:

1. **Three (3) Core subjects** Choose any three subjects from the following:

- Assamese, English, Hindi, Folklore, Linguistics, Economics, Political Science, History, Education, Geography, Anthropology, statistics, Mathematics, .

2. **Multidisciplinary Subject** (any one subject mentioned in course structure).

3. **AEC:** English Communication I (compulsory).

4. **VAC:** Environmental Education (compulsory)

5. **SEC:** Compulsory.

(Major Courses: ,English, Assamese, Hindi, Economics, Political Science, History, Education, , Geography, Anthropology, Mathematics and Statistics).

N.S.S. (National Service Scheme)

Dimoria College NSS unit is active since 1985 and has organised various programmes since its inception. The National Service Scheme (NSS) is a student youth service programme. This scheme is sponsored by the Ministry of Youth Affairs and Sports, Govt. of India.



NSS Volunteers participating in Swachhata Hi Sewa organized by Geological Survey of India and Plantation near the Swimming Pool respectively.

For choosing a combination of three (3) core subjects, please check the table given below:

Arts			Interdisciplinary		
MIL	Other Language	Social Sciences	Language & Culture	Performing Arts	Interdisciplinary-A
Assamese	Arabic	Economics [†]	Folklore	Sattriya Tradition	Journalism & Mass Communication
Bengali	English	Education	Linguistics		Library & Information Science
Bodo	Persian	History			Community Science (Home Science)
Hindi		Philosophy			Human Rights Education
Manipuri		Political Science			
Nepali		Psychology			
Sanskrit		Sociology			
			Commerce & Management		
			Travel & Tourism Management		
Max 1	Max 1	Max 3	Max 1	Max 1	Max 1

[†] Dual-Stream subjects

Combinations of Subjects for Science:

FYUGP in Science:

1. **Three (3) Core Subjects:** Choose any three subjects from the following:

- Physics, Chemistry, Mathematics, Botany, Zoology, Geology, Anthropology, Geography, Computer Science, Statistics, Biotechnology, Economics.
2. **Multidisciplinary Subject** (any one subject mentioned in course structure).
3. **AEC:** English Communication I (compulsory).
4. **VAC:** Environmental Education (compulsory)
5. **SEC:** Compulsory.

(Major Courses: Physics, Chemistry, Botany, Zoology, Geology, Mathematics, Anthropology, Geography, Computer Science, Statistics and Economics).

Institution Innovation Council

Innovation is the cornerstone of progress, and educational institutions play a pivotal role in nurturing a culture of innovation among students and faculty. At Dimoria College, we recognize the importance of innovation in driving societal advancement and economic growth. To catalyze this process, Institution Innovation Council (IIC) serves as a dedicated platform for fostering creativity, entrepreneurship, and problem-solving skills among our academic community.



Activities carried out under Institutional Innovation Council.

For choosing a combination of three (3) core subjects, please check the table given below:

Science			
Physical Science	Biological Science & Anthropology	Earth & Environmental Science	Computer & Information Science
Physics / Electronics Science	Anthropology [†]	Environmental Science	Computer Science
Chemistry	Botany	Geology	Computer Application
Mathematics [†]	Zoology	Geography [†]	
Statistics	Biotechnology		
Instrumentation	Microbiology		
Max 3	Max 2	Max 1	Max 1

[†] Dual-Stream subjects

For FYUGP Programme Course Structure of arts & science please refer to page no. 21-24 or visit

1. <https://nep.gauhati.ac.in/fyugp#h.yg16qelkap89>

2. Add a little bit of body text

3. <https://nep.gauhati.ac.in/util> For Detailed Regulations GU-GYUGP..

Fee: As per Government Instructions.

BESIDES HS, UG & PG COURSES WE OFFER

2. Diploma Courses –

- Post Graduate Diploma in Computer Application (PGDCA),

Eligibility: Graduate in any discipline

2. Certificate Courses on:

- Spoken English & Personality Development
- Fundamentals of Semiconductor
- Rural Marketing
- Applied Financial Markets.
- Fundamentals of Remote Sensing & GIS
- Nursery & Gardening
- Vermicomposting Technology
- Mushroom Cultivation
- Geological Surveying
- Data Analysis using Advanced Computational Tool (MATLAB)
- Trade & Tourism Management
- Bio-data Writing.

- Facing an Interview.
- Farm Management.
- Nursery Management
- Integrated Fish Farming & Horticulture
- Professional Hindi
- অসমৰ মুখা শিল্প: সাংস্কৃতিক আৰু অৰ্থনৈতিক দিশ
- Human Rights Education
- Good Governance
- Panchayati Raj in India
- Gender and Equality
- Map Making
- Hospitality Management
- Sattriya Dance

3. Vocational Courses on:

- Computer Application (Intake capacity 25)
- Travel and Tourism Management (Intake capacity 30).

4. Ph.D Supervisors:

- Dr. Mahananda Borah (Geology, Gauhati University)
- Dr. Keemee Das (Geography, Royal Global University)
- Dr. Jahidul Haque (Economics, Royal Global University)

POST GRADUATE COURSES OF STUDY

i) Master of Arts in Assamese (Affiliated to Gauhati University)

In the year of 1993, the Department was upgraded to provide Post Graduate education after receiving the permission from its affiliating University (Gauhati University). The department has its long walk till present and crossed silver jubilee in the year of 2018. The department was created to bring the light of knowledge to the rural and tribal dominated area of Dimoria, and with this very goal in mind; the department even now striding forward, to spread this light of knowledge far and wide. The department was built with the determination and contribution of many renowned local and national personalities and without their help the efforts of the department would have been short lived.

The Department has followed the objective of imparting higher education in Assamese language, literature, culture and other relevant disciplines. The Post Graduate Department of Assamese is a leading Department of Dimoria College, Khetri. From the very beginning of the Department it is earning Forward of research & Extension to the Community development of North-East region above meth teaching & learning of Assamese language, literature & Culture both under Graduate and Post-Graduate level.

ii) Master of Arts in Economics (Affiliated to Gauhati University)

The PG Department of Economics can trace its origins to the birth of Dimoria College in 1979. The department was created to bring the light of knowledge to the rural and tribal dominated area of Dimoria, and with this very goal in mind; the department is even now striding forward, to spread this light of knowledge far and wide. For this, the Department also received permission from its affiliating university (Gauhati University) to offer Post Graduate education in the department from 1992. Throughout its rich and varied history of more than 40 years, the Department of Economics has catered to the educational needs of students from different parts of the State. The Department was built with the determination and contribution of many renowned local and national personalities and without their help the efforts of the department would have been short lived. The efforts made by the department, can be seen in its rich Alumni, who are presently employed all over the country. The Department has conducted many National Seminars, Workshops and popular talks, field trips, excursion to further increase the knowledge of its students in the field of economics. The Department also possesses a library, having more than 1000 books, 03 Journals, and 07 computers to help the students in their studies. The department also possesses a digital classroom, fixed with LCD Projector.

iii) Master of Science in Geology (Affiliated to Gauhati University)

MSc Geology is a postgraduate degree course of 2- year duration, divided into four semesters. This course basically teaches students about the surrounding environment and focuses on the scientific study of the workings and design of the earth and its layers. The geology department gets its permission to open post graduate courses in Geology in 2017.

iv) M.Sc. in Environment Management (Affiliated to Gauhati University)

The Department of Environment Management, an innovative full time M.Sc. Course sponsored by UGC, 2008, and affiliated to Gauhati University, has been running successfully. The department is engaged in solving various environmental problems of the locality through field visits, survey, collection of data and dissemination of the same to the public for better management. The department regularly organizes seminars and group discussion among the students on current environmental issues. The department has a sophisticated laboratory and internet facility. The faculty members are also engaged in various research works. This course bears a high potential for placement.

POST GRADUATE COURSES OF STUDY

v) Master of Science in Eco-Restoration (Affiliated to Dibrugarh University)

Highlights of the P.G. Eco-Restoration Course

- Ecological Restoration Information Centre
- International Collaboration
- International Visiting Faculties
- Compulsory Field Project Work
- Personality Development
- Certified Workshop and Training
- National & International Summer Training Programme.

Brief outline of Eco-Restoration Course

1. UGC approval and assistance for M.Sc. Eco Restoration Programme was received under innovative programme-teaching and research in interdisciplinary and emerging area vide letter No. F.14-42/2004 (Inno.Asist) dtd. 31-03-04. The first & the second batches of M.Sc. Eco-Restoration Programme secured 100% 1st Class result in the final semester and almost 100% of them got placement in good sectors.
2. The first Regional Eco-Restoration Resource Centre was inaugurated by Prof Andre Clewell, Restoration specialist, USA and Dr. N.R. Desai, Executive Director, Society for Ecological Restoration, Indian Chapter, Pune in 2005.
3. The Department of Eco-Restoration is working in collaboration with the society for Ecological Restoration India, since 2004
4. The Wildflower Satellite Centre was inaugurated by Richard Scott, Land life, National Wildflower Centre, Court Hey Park, Liverpool, UK in 2006.
5. The Department organized the 1st International Conference on Restoration Ecology in 2005 wherein keynote address was delivered by James C. Aronson, Researcher & Head, Restoration Ecology Group, Centre
6. L. Embergerd 'Ecologie Fonctionnelle et Evolutive, Montpellier, France and A.F. Clewell, Eco-Restoration Specialist, USA.

Sankardeva Studies Cell

The Sankardeva Studies Cell of the Postgraduate Assamese Department of Dimoria College started on March, 2023. The Under Graduate and Post Graduate syllabus of the Assamese Department requires students to study the literature of Sankardeva and Satriya Culture. The Cell provided many Sanskrit and mythological books along with the works of Sankardeva and Vaishnava texts.



FEES STRUCTURE FOR POSTGRADUATE COURSES SESSION 2024-25

Semester	Assamese	Economics	Eco-Restoration	Environment Management	Geology
1st	13,000/-	13,000/-	20,000/-	20,000/-	20,000/-
2nd	11,000/-	11,000/-	16,000/-	16,000/-	16,000/-

Note: Students have to pay the respective University Examination fees separately.

Semester	Assamese	Economics	Eco-Restoration	Environment Management
3rd	11,000/-	11,000/-	16,000/-	16,000/-
4th	11,000/-	11,000/-	16,000/-	16,000/-

Note:

1. Students have to pay the respective University Examination fees separately.
2. The above fees structure will be applicable for new students.

Indigenous Community Study Centre

The Indigenous Community Study Centre, Dimoria College, established in the year 2023 mainly focused on researching, preserving, and promoting the cultures, traditions, and knowledge systems of indigenous communities of Dimoria region. It serves as a hub for academic study, community engagement, and cultural revitalization efforts. The centre typically offers resources such as archives, libraries, and educational programs to support both indigenous

communities and broader society in understanding and appreciating indigenous heritage.

Objectives:

- To study the ethnic culture, language and traditions of the various indigenous communities of Dimoria region.
- To preserve and develop the respective ethnic culture, language and tradition of the various indigenous communities of the region.
- To carryout research that is grounded in Indigenous knowledge systems and worldviews.



RULES AND REGULATIONS

COLLEGE RULES:

1. A student must clear his/her College dues at the time of admission. A student has to pay Rs. 50/- (Rupees fifty only) as caution money which is refundable.
 2. An Identity Card is issued to every student which should be brought to the College daily.
 3. Students are entitled to Students' Travelling Concession on production of identity card as per rule.
 4. Any society or association shall be subject to the guidance and control of the administration.
 5. Only such Societies / associations which are recognised by the College shall have the facilities of the College premises.
 6. All notices desired to be circulated by the students anywhere in the College premises shall require the approval of the Principal.
 7. Any of the following acts by a student shall be considered as a major breach of College discipline:
 - a. Habitual irregularity.
 - b. Resorting to violence of any kind.
 - c. Disobedience and indecent behavior to teachers and College authority.
 - d. Damaging, defacing or devaluing of any College property.
 8. All students must attend classes and other activities of the College in the uniforms prescribed by the College authority.
- Ragging is strictly prohibited and students found involved in this activity will be dealt with as per Govt. rule.

Registration and Migration: Students whose names are not registered in Guwahati University or Assam State School Education Board (A.S.S.E.B) must pay registration fees at the time of Admission. Students from Boards or universities other than SEBA and GU will have to produce Migration Certificate at the time of Admission. M.Sc. Eco- Restoration students whose names are not registered in Dibrugarh University must pay registration fee at the time of admission.

Attendance: It is compulsory for every student to attend classes regularly and punctually. Willful absence from the class room will be treated as a serious breach of College discipline. Each student is required to attend a minimum of 75% of the total lectures delivered. Failing which student will be considered as non-collegiate and he/she will have to pay fine of Rs.500/-

Examinations: Besides the examination conducted by the A.S.S.E.B. and GU, the College also conducts Mid- Term Examinations, Unit Tests etc. There is also a provision for monthly tests in all subjects which are independently conducted by the respective departments. The whole examination system is fully computerised.

Evaluation: All students must sit for unit test, sessional examinations and finish their assignments, projects and field report within the stipulated dates. Performance of the students in these tests will determine marks of the internal assessment at the end of the semester/year.

Prescribed Uniform:

- Boys: Light blue shirt with Grey trouser.
- Girls: Light blue salwar suit with Grey borders and Grey Churni
- Grey Coloured Sweater for both Boys & Girls Students.

PRINCIPAL AND TEACHING STAFF OF THE COLLEGE

Principal i/c: Mr. Manabjyoti Barkakaty

TEACHING STAFF OF THE COLLEGE

POST-GRADUATE DEPARTMENT OF ASSAMESE

1. DR.NISHIGANDHA TALUKDAR, M.A., Ph.D.
2. DR.PANKAJ NAMASUDRA, M.A. (Double), M.Phil, Ph.D, HoD.
3. DR. SNIGDHA KATAKY, M.A., Ph.D
4. MINAKSHEE BORUAH, M.A., M.Phill
5. DR. ALAKANANDA SAIKIA, M.A., B.Ed, M.Phil, Ph.D.
6. DR.NIRU THAKURIA, M.A., M.Phil., Ph.D.
7. MRS.PALLAVI CHOUHURY, M.A.

DEPARTMENT OF LINGUISTICS

1. MR.PRANAB KR.BARUAH, M.A., M.Phil, HoD
2. MR.NAREN MEDHI, M.A. (Double), M.Phil.

DEPARTMENT OF FOLKLORE

1. DR.UTPAL BAISHYA, M.Sc., M.Phil, PhD, HoD.
2. MRS. CHANDANA PHUKAN, M.A.

DEPARTMENT OF ENGLISH

1. MRS.AFRIN NAHAR, M.A.,HoD.
2. MR. HIMANGSHU SARMA, M.A., M.Phil.
3. MR. ANUP DUTTA BARUAH, M.A., M.Phil.
4. DR. JHARNA CHOUDHURY, M.A., Ph.D.

POST-GRADUATE DEPARTMENT OF ECONOMICS

1. DR. MINAKSHI BAYAN BORAH, M.A., M.Phil, PhD, HoD
2. MR. KAPIL RAHANG, M.A., B.Ed.
3. MR. SAHADEV MILI, M.A., M.Phil.
4. DR. BIPUL KUMAR DAS, M.A., Ph.D
5. DR. LAKHIMI NATH, M.A., Ph.D.
6. MISS. MASUMA AHMED, M.A..
7. DR. JAHIDUL HAQUE, M.A., Ph.D.

DEPARTMENT OF HISTORY

1. MR. BIREN BHUYAN, M.A., HoD.
2. MR. HIMANGSHU MARAL, M.A.,L.L.B.
3. MR. DIGANTA DAIMARY, M.A., M.Phil.
4. MISS SUSHMITA BORDOLOI, M.A.

DEPARTMENT OF POLITICAL SCIENCE

1. MRS. ARCHANA SAHARIA, M.A., M.Phil, HoD.
2. MRS. JUNU RAHANG, M.A., B.Ed.
3. MRS. K.NEISI SINGSON, M.A.
4. DR. KAKOLI DAS, M.A., B.Ed., Ph.D.

DEPARTMENT OF EDUCATION

1. DR. ANJAN KR. RABHA, M.A., B.Ed, PhD,
2. DR. ANEK LAL BARMAN, M.A., M.Phill, Ph.D, HoD.
3. MISS RASHMI REKHA RABHA, M.A., M.Phil
4. MISS KALPANA BAISHYA, M.A.

DEPARTMENT OF HINDI

1. MR. MOHINI MOHAN DEKA, M.A., HoD.
2. MRS. SEWALI KALITA TALUKDAR, M.A., M.Phil.
3. DR. JASHODHARA BORA, M.A., Ph.D.
4. MRS. SANGITA KAKATI, M.A., M.Phil.

DEPARTMENT OF GEOGRAPHY

1. MR. MANAB JYOTI BARKAKATY, M.Sc., M.Phil, HoD
2. MR. SOURAV CHETIA, M.A., M.Phil.
3. DR. KEEMEE DAS, M.Sc., Ph.D.
4. DR. KRIPAL PANGING, M.A., Ph.D.

DEPARTMENT OF MATHEMATICS

1. MR. AMAL CH. ROY, M.Sc., HoD
2. MR. ACHYUT MALAKAR, M.Sc., M.Phil.
3. DR. MANJURI DUTTA, M.Sc., Ph.D.
4. MISS SANCHITA CHETIA, M.Sc.

PRINCIPAL AND TEACHING STAFF OF THE COLLEGE

Principal i/c: MR. Manabjyoti Barkakaty

TEACHING STAFF OF THE COLLEGE

DEPARTMENT OF PHYSICS

1. MR. DEWAN SAFIWUR RAHMAN, M.Sc. (HoD)
2. DR. PRATIMA DUTTA, M.Sc., Ph.D.
3. MR. BHASKAR JYOTI DEKA, M.Sc.

DEPARTMENT OF CHEMISTRY

1. MR. ANGIRA BHAGAWATI, M.Sc. M.Phil., HoD.
2. MRS. MIRA GOSWAMI, M.Sc.
3. DR. HIMARANI KALITA, M.Sc., Ph.D.
4. DR. SHIVANEE BORPATRA GOHAIN, M.Sc. Ph.D
5. DR. PRATAP CHUTIA, M.Sc., Ph.D

DEPARTMENT OF BOTANY

1. DR. ALEE SARMA, M.Sc., Ph.D, HoD.
2. DR. S.A.I. CHOUDHURY, M.Sc., Ph.D.
3. DR. SARAJU HAZARIKA, M.Sc., Ph.D.
4. DR. SIVA PRASAD KONWAR CHETRI, M.Sc., M.Phil, Ph.D.

DEPARTMENT OF ZOOLOGY

1. DR. DHRUBA JYOTI SARMA, M.Sc., D.Sc. (Hon'ry), HoD.
2. MR. SUNIL KR. DEKA, M.Sc.
3. DR. DIPANKAR BUJARBARUAH, M.Sc., Ph.D
4. MISS SHREYASI BARMAN, M.Sc.

DEPARTMENT OF GEOLOGY

1. DR. MAHANANDA BORAH, M.Sc., Ph.D, HoD.
2. MS. MADHURIMA BARUAH, M.Sc.
2. DR. PARTHA PRATIM GOGOI, M.Sc., Ph.D
3. MR. RAHUL SAIKIA, M.Sc.

DEPARTMENT OF ANTHROPOLOGY

1. DR. KALPANA CHOUDHURY, M.A., Ph.D.
2. DR. KIRSHNA KR. BORAH, M.Sc., Ph.D., B.Ed. HoD
4. MRS. BANASMITA NATH, M.Sc., Ph.D
5. MISS RUPREKHA SAIKIA, M.A.

DEPARTMENT OF COMPUTER SCIENCE

1. MR. PANKAJ BHATTACHARJYA, M.C.A., M.Phil,
2. DR. HITESH CHOUDHURY, M.Sc (Double, Maths and computer science), M.Phil., Ph.D., HoD
3. MISS PRIYA KARMAKAR, M.Sc.

DEPARTMENT OF STATISTICS

1. DR. LUKU DEKA BARMAN, M.Sc., Ph.D., HoD
2. MRS. ANJU DEVI, M.Sc.

DEPARTMENT OF BIO-TECHNOLOGY

1. DR. SULTAN.A.I. CHOUDHURY, M.Sc. Ph.D.,
2. DR. ALEE SARMA, M.Sc., Ph.D.
4. DR. JHARNA DAS, M.Sc., Ph.D., HoD

POST-GRADUATE DEPARTMENT OF ECO-RESTORATION

1. MRS. JONALI BARMAN. M.Sc., HoD
2. Dr. MAHANANDA BORAH, M.Sc., Ph.D
3. Dr. SIVA P. K. CHETRI, MSc., Ph.D
4. DR. DHARITRI CHOUDHURY, M.Sc., Ph.D.

POST-GRADUATE DEPARTMENT OF ENVIRONMENTAL MANAGEMENT

1. DR. PRATAP CHUTIA, M.Sc., Ph.D., HoD.
2. DR. SULTAN.A.I. CHOUDHURY, M.Sc. Ph.D.
3. DR. PARTHA PRATIM GOGOI, MSc, Ph.D
4. MRS, DULUMONI TALUKDAR, M.Sc.

LIBRARIAN

1. MISS BANANI DAS, MLISc, M.Phil.

NON-TEACHING STAFF OF DIMORIA COLLEGE

1. MR. CHENI RAM DEKA, HEAD ASSTT.
2. M R. NARAYAN DAS JUNIOR ASSISTANT
3. MR. RAJAT KUMAI, LAB.ASSTT
4. MR. SOURAV DAS, L.D.A.
5. MR. DIPANKAR BORDOLOI, JR. ASSISTANT
6. MR.BHARAT BAISHYA, LAB. BEARER
7. MRS.PHULMONI DEKA, LAB. BEARER
8. MRS. MANTIMA PATHAK , LAB.BEARER
9. MR. DIPAK THAKURIA, LAB.BEARER
10. MR. RANJIT DAS, LAB.BEARER
11. MR. PARITOSH NATH, LAB.BEARER
12. MR. SULESWAR BORO, LAB.BEARER
13. MR. ASHIM CHANDRA DEKA, LAB. BEARER
14. MR. JOHN SANGMA, LAB.BEARER
15. MRS. MINATI MARME, LAB.BEARER
16. MR. LUDU SING BARUAH, LAB.BEARER
17. MR. NAGEN BORDOLOI, LAB.BEARER
18. MR. BHAGAWAT BEHERA, GRADE IV
19. MR. ARUN NATH, GRADE IV
20. MRS. URMILA BAISHYA, GRADE IV
21. MRS. NILIMA DAS, LAB.BEARER
22. MRS. URMIMALA DEKA, LAB.BEARER
23. MS. DULUMA DEKA, LAB.BEARER
24. MR. ANTON DEKA, LIB. BEARER
25. MRS. BIJUMONI KALITA, LIB.BEARER
26. MR. ARUP KUMAR BHARALI, LAB. BEARER
27. MR. ARUN NATH, GRADE IV
28. MR. AJANTA DEURI, LAB.BEARER
29. APARAJITA HAZARIKA, GRADE IV
30. MR. GAJENDRA GAUR, GRADE IV
31. MR. BIREN BAISHYA, GRADE IV
32. MS. MAKANI LALUNG, LAB.BEARER
33. MR.BRAJALAL SARKAR, LIB.BEARER
34. SEWALI MEDHI TARANG GRADE IV
35. MRS. DEBI KRO, GIRLS HOSTEL COOK
36. MRS. UNOI KATHAT, HOSTEL COOK
37. MS. SHANTI BAISHYA, HOSTEL COOK
38. MS. DINU TERON, HOSTEL COOK
39. BISWAJIT TUMUNG GRADE IV
40. MONTU KAIBARTY, CLEANER.

Dimoria College Students' Union

D.C.S.U. is the General Body of the students of the College. Its membership is compulsory for every Dimorian. Office bearers are elected annually as per the constitution of the Student's Union.



The FYUGP course structure of Gauhati University

1. The credit framework

Each semester of a 4-Year Bachelor Degree (FYUGP) course will have a maximum of 22 credits with a total of 132 credits for 3-Year Degree Course and 176 credits for a 4-Year Degree Course. Apparently, the Masters Course will have 44 credits in a year with a total of 88 credits in two years. The baseline for total credits is 120 for a 3-Year course and 160 for a 4-Year course. So, a student can choose to have a total credit between 120 and 132 by the end of a 3-Year Bachelor Degree course.

1.1 Division of credits

The basic division of credits for a 3-Year Bachelor Degree course is shown in Table 1. The basic division for a 4-Year Bachelor Degree is shown in Table 2 and Table 3. In the 4th year, there are however two options – (a) Degree with Honours and (b) Degree with Honours and Research. Overall, a 3-Year Degree course consists of two sections – a Core Section and a Common Section. While the Core Section consists of Major and Minor papers, the Common Section is divided into 5 sub-groups.

1.1.1. Multi-disciplinary Courses

These are 3-credit courses spanning over five different groups of subjects – (i) Natural and Physics Science, (ii) Mathematics, Statistics, and Computer Applications, (iii) Library, Information, and Media Sciences, (iv) Commerce and Management, and (v) Humanities and Social Sciences. The level of these courses is of Class XII.

1.1.2. Ability Enhancement Courses (AEC)

This is a 8-credit course covering Modern Indian Languages (MIL) and English Usage (Communication).

Degree with Major/Minor						120 Credits	
Core		Common Course					
Major	Minor	Multi-Disc	AEC	SEC	VAC	Internship	
60	24	9	8	9	6(8)	4(2)	

Table 1: The minimum division of credits for a 3-Year Bachelor Degree Course.

Degree with Honours					160 Credits	
Research Methodology	Advance	Dissertation	Common Optional		Open	
			SEC	Internship		
4	24		4		8	

Table 2: Minimum division of credits for a 4-Year Bachelor Degree Course with Honours

1.1.3. Skill Enhancement Courses (SEC): These are various skill courses with total credit allocation of 9. In our structure, we shall have four skill courses starting from Semester III.

1.1.4. Value-based Courses (VAC): The VAC courses will come from four sub groups – (i) Understanding India, (ii) Environmental Science, (iii) Digital and Technological Solutions, and (iv) Health & Wellness, Yoga Education, Sports, and Fitness. All together they will have a credit allocation of 6.

1.1.5. Internship: All students are to carry out an Internship with a credit allocation of 4.

Degree with Honours & Research		160 Credits
Research Methodology	Research Project/Dissertation/Internship/Skill	
4	36	

Table 3: Minimum division of credits for a 4-Year Bachelor Degree Course with Honours and Research.

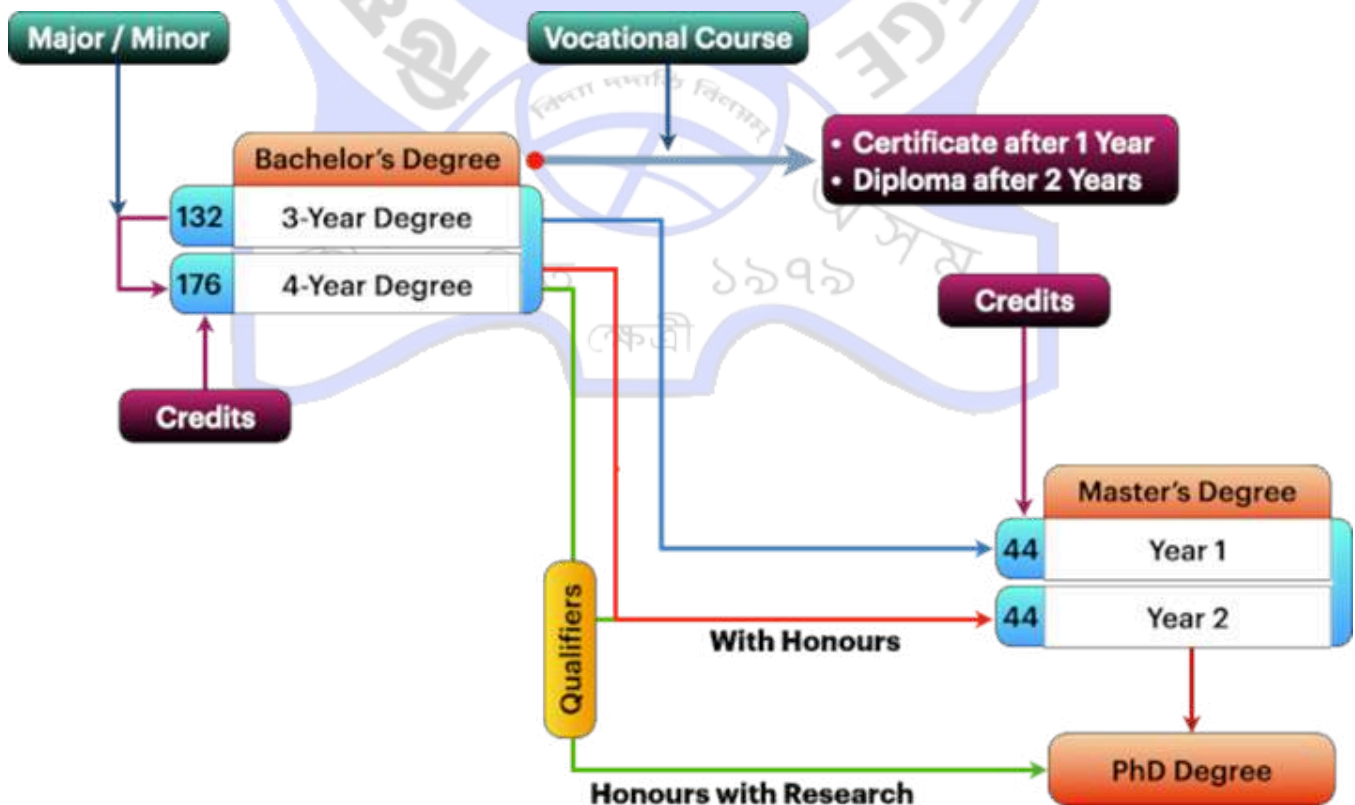

Figure 1: Progression scenario

1.1.1. Description of divisions

As shown in the figures, the base credit score for a 3-Year course is 120 and a student needs to have at least 50% of 120 i.e. 60 credits in a subject to qualify for a major in that subject. In the same way a minor course will have 12 credits and a student can have two minors with a total of 24 credits. Apart from the Major subject, if a student can obtain 48 credits in a particular subject, the student will get a double major.

1.1. Allocation of credits

Following are the allocation of credits for different courses (papers)

- Core (Major & Minors) 4 Credits (3 Theory + 1 Practical OR 4 Theory)
- Multidisciplinary 3 Credits (2 Theory + 1 Practical OR 3 Theory)
- AEC 4 Credits (all theory)
- SEC 3 Credits (2 Theory + 1 Practical OR 3 Theory), 2 Credits (1 Theory + 1 Practical OR 2 Theory)
- VAC 3 Credits (2 Theory + 1 Practical OR 3 Theory)
- Internship 4 Credits

2. Progression

The progression during the whole course structure is shown in Fig.1. As seen from the figure, there are three pathways to the doctoral course or PhD course:

- After 3-Year Bachelor Degree: After a 3-Year Bachelor Degree, a student can take admission in the 2-Year Masters Course and advance to doctoral program. This pathway is similar to what we have now.
- After 4-Year Bachelor Degree with Honours: Students completing a 4-Year Bachelor Degree with Honours will take admission into the second year of Masters program and can advance to the doctoral program.
- After 4-Year Bachelor Degree with Honours and Research: This pathway is for only exceptional students who can directly advance to a doctoral program right after graduation. So, there shall be a necessary qualifier process which will ensure that only high quality motivated students can take this pathway. All other students must go through the second year Masters program in order to be able to take admission in a doctoral program.

Red Ribbon Club



Red Ribbon Club is sponsored and supported by the Assam State AIDS Control Society (ASACS). The students are trained in AIDS awareness and motivated for voluntary Blood Donation.

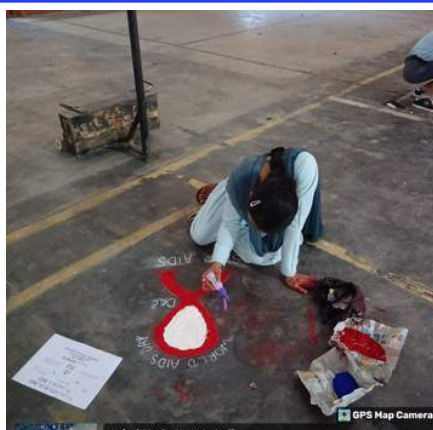

Course Structure

Here, we describe the 3-Year Bachelor Degree course. The 4th year of the Bachelor Degree course will be dealt separately. The detailed course structure is represented in Figure 2. This structure depicts a general scenario where a student will choose one major course and two minor courses. It is to be noted that in order for a re-entry into the 3-Year course in Semester III or V for students who have opted for leaving the course after the 1st and 2nd year respectively, additional vocational course of 4-credit has to be done by the student on exit.

In what follows, we give four examples for

- **3-Year Bachelor Degree with one major and two minors**
 - Degree obtained: For example, Bachelor Degree in Arts with Major in History and Minor in Political Science and Economics.

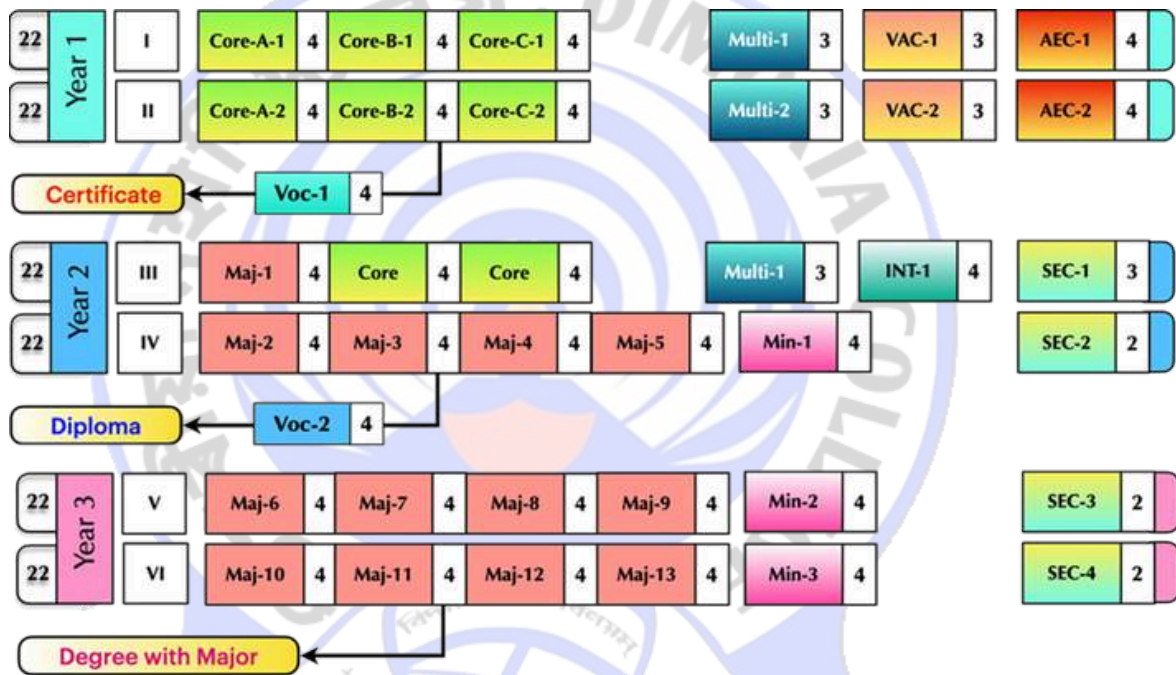

- **3-Year Bachelor Degree with three minors:**
 - Degree obtained: For example, Bachelor Degree in Arts or Bachelor degree in Science

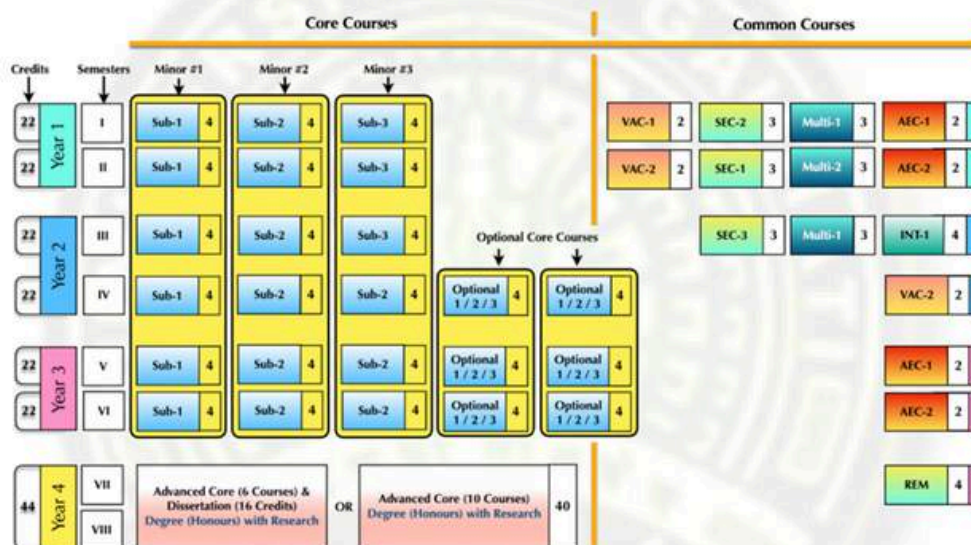

Figure 3.2: Core Courses options — Option with only Minors.

Entrepreneurship Devpt. Cell (EDC)

An Entrepreneurship Development Cell has opened by the college to boost entrepreneurship among the students of the college. To achieve its objectives, the cell organizes talks, seminars & workshops on entrepreneurship.



Yoga Centre

The college fraternity strongly believes that Yoga keeps students and faculty healthy and fit. With this objective in mind the college has opened a yoga centre, which frequently organizes yoga training sessions to the college's staff and students.



Gymnasium

The college has a gym which serves as an indispensable hub for promoting health, fitness, and overall well-being among students, faculty, and staff. With its state-of-the-art equipment, the gym offers a dynamic space for individuals to engage in various physical activities.



National Seminars

Dimoria college have been organizing other academic programmes like National and International seminars, symposiums, debate, lectures, quiz competitions from time to time in the college. In 2022 and 2023, two ICSSR sponsored National Seminar has been organised by the department of Education and Economics respectively



ICSSR Sponsored national seminar on Present Status of Agriculture and Allied Activities in India: Problems and Prospects



ICSSR Sponsored national seminar on National Education Policy, 2020

Snapshots from NAAC Peer Team Visit



